

3 MINI-X Overview

MINI-X embodies the newest generation of miniature guideways for demanding applications. They are extremely robust and prove themselves in every application with their high level of smoothness, precision and reliability.



MINIRAIL

MINIRAIL – The miniature profiled linear guideway

- Process reliability thanks to superior design
- Speeds up to 5 m/s and acceleration up to 300 m/s²
- The precisely finished carriages can be interchanged as desired
- Low risk of contamination thanks to tight clearance between the carriage and guideway
- Low travel pulsation thanks to optimally shaped ball recirculation
- Vacuum-compatible down to 10⁻⁷ mbar (10⁻⁹ mbar on request)
- The long-term lubrication LUBE-S option enables maintenance-free operation
- Unlimited rail length

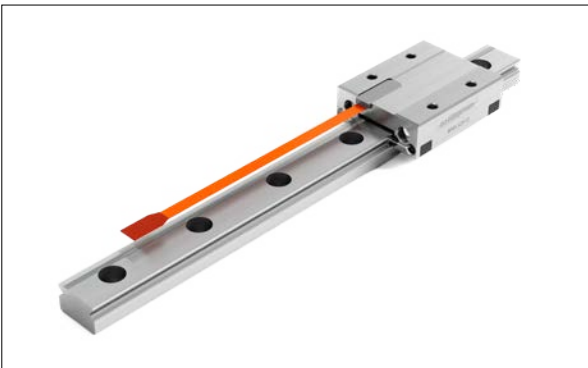

MINISCALE PLUS

MINISCALE PLUS – Guiding and measuring in one

- Due to the fact that the measuring system requires very little space, very compact designs can be implemented
- Simple installation since the distance measurement does not need calibration
- Additional components and their installation are not necessary
- Optimal thermal connection to the machine bed
- Global drive compatibility



MINISLIDE MS

MINISLIDE MS – Maximum performance, minimum space

- The Gothic arc profile of the guideways allows for load capacities which are up to 15 times higher than that of a 90° V-profile
- MINISLIDE MS enables compact and robust constructions with minimal weight
- The material used and the outstanding design allow for a high level of rigidity
- Vacuum-compatible down to 10⁻⁷ mbar
- Cage centring system



MINISLIDE MSQ

MINISLIDE MSQ – Productivity encapsulated

- Maximum process reliability thanks to integrated cage control
- The snug, two-row profile of the guideways allows high load capacities, and because of the materials used, unrivalled rigidity
- MINISLIDE MSQ enables compact and robust constructions with minimal weight
- Vacuum-compatible down to 10⁻⁹ mbar

4 Applications

MINI-X is used in situations where high precision and process reliability are needed due to constricted space. The unique advantages of MINI-X come into their own in the following applications:

- Processing machines for the micro-sector
- Biotechnology
- Semiconductor industry
- Laboratory automation
- Medical technology
- Metrology
- Micro-automation
- Nanotechnology
- Optics industry
- Robotics

Modern microscopes are indispensable in research and in day-to-day medical processes. In order to analyze the samples quickly and accurately, the slide underneath the lens has always been moved by means of a cross table.



Microscope with scan table



Scan table

The Scan table shown is based on MINIRAIL and MINISCALE PLUS; the drive is provided by linear motors. Using these compact components reduces the weight compared with conventional constructions (ball screws and multiphase motors) by a factor of around five. The scan table is not only fast but also decidedly quiet. Precision in the smallest area - reproducible with an accuracy of several microns.

4 Applications

Use of MINISLIDE

The precision and speed of flying probe testers are extremely important for the electrical testing of structures measuring just 50 μm or less. The high acceleration in particular must not affect the contact accuracy of the test design.

The manufacturer offers different machine configurations for a wide range of products. An extremely wide range of materials and designs, including rigid and flexible PCBs and everything from IC packages to touch panels, can be tested with the latest machine generation.



The flying probe test system

| | |
|------------------|--|
| Acceleration: | 30 g |
| Working stroke: | 1 – 2 mm |
| Total stroke: | 10 – 15 mm |
| Reproducibility: | 1 – 2 μm at the point of work |
| Lubrication: | Maintenance-free after initial lubrication |

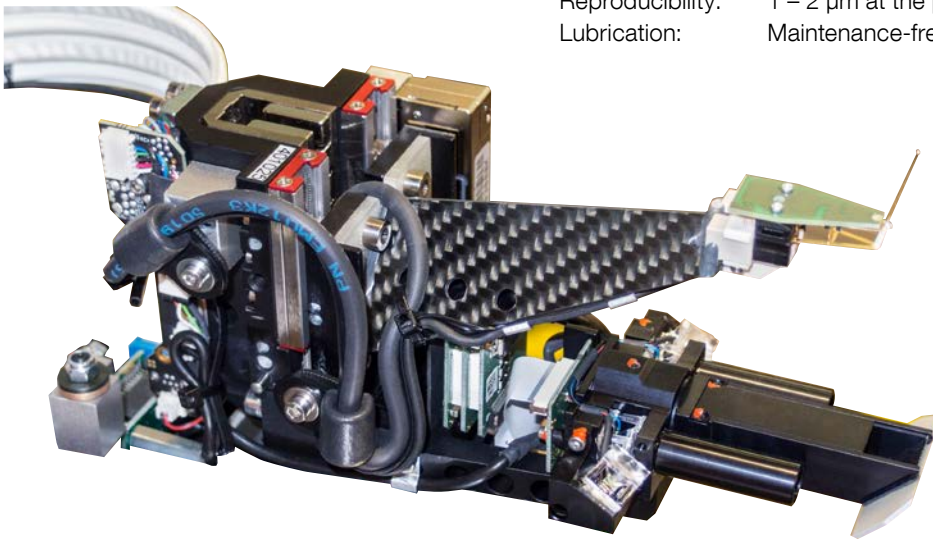

Test head with modified MINISLIDE MSQ 7 40.32

5 Customized Solutions

SCHNEEBERGER's many years of experience in linear motion technology have influenced the concept and design of MINI-X. Due to their outstanding performance parameters, MINI-X plays a decisive role in the accuracy of every application.

MINI-X are universally applicable. SCHNEEBERGER offers configurations upon request for application-specific requirements, including:

- Defined push forces
- Application-specific lubrication
- Special packaging
- Hybrid guideways with ceramic ball bearings
- Coatings for dry runs
- Customer-specific design
- Defined cage reset force
- Defined records



Installation in SCHNEEBERGER's cleanroom

Examples of customer-specific MINI-X products

MINIRAIL with vented holes in carriages and guideways, vacuum-packed for use in cleanrooms.



MINIRAIL modified according to the requirements of the customer

MINISLIDE MSQ finished specifically to the customer's needs.



MINISLIDE MSQ finished according to the requirements of the customer

MINISLIDE MS with ceramic ball bearings, additional holes and positioning pins. Push and cage reset forces are defined and recorded.



MINISLIDE MS modified and specified according to the requirements of the customer

6 Special Requirements

6.1 Temperature Range

MINI-X can be operated in different temperature ranges. SCHNEEBERGER can deliver guideways with application-specific lubricants on request.

| Operating temperature | |
|-----------------------|--|
| MINIRAIL | -40 °C to + 80 °C (higher temperatures on request) |
| MINISCALE PLUS | -40 °C to + 80 °C |
| MINISLIDE MS | -40 °C to + 80 °C |
| MINISLIDE MSQ | -40 °C to + 150 °C |

6.2 Speeds and Acceleration

MINI-X are equipped for the following speeds and acceleration:

| | max. speed | max. acceleration |
|----------------|------------|----------------------|
| MINIRAIL | 5 m/s | 300 m/s ² |
| MINISCALE PLUS | 5 m/s | 300 m/s ² |
| MINISLIDE MS | 1 m/s | 50 m/s ² |
| MINISLIDE MSQ | 3 m/s | 300 m/s ² |

6.3 Cleanroom

In the cleanroom, it is necessary to reduce the number of particles as well as apply appropriate types of lubricating grease. SCHNEEBERGER delivers guideways for cleanroom classes up to ISO 6 on request. The guideways are packaged appropriately and lubricated according to requirements.

6.4 Vacuum

Corrosion resistant guideways are preferred for use in a vacuum. It is also necessary to avoid out-gassing of plastics, to ensure vented of attachment holes and to use an appropriate lubricant.

On request, SCHNEEBERGER can deliver the guideways packaged in a cleanroom and lubricated according to requirements.

| Vacuum ranges for standard MINI-X products: | |
|---|---|
| MINIRAIL | 10 ⁻⁷ mbar (HV). 10 ⁻⁹ mbar (UHV) on request. The values apply without wipers |
| MINISCALE PLUS | On request |
| MINISLIDE MS | 10 ⁻⁷ mbar (HV) |
| MINISLIDE MSQ | 10 ⁻⁹ mbar (UHV) |

Notes: the suitability for a vacuum depends on the materials used.

6 Special Requirements

6.5 Corrosion Resistance

Corrosion protection is not just required in a cleanroom or vacuum. Medical, laboratory or food applications demand corrosion-resistant steel, as used in all MINI-X products.

6.6 Short Strokes

The effects of short strokes include point compression along the tracks and inadequate lubrication. As a result, short strokes reduce the service life of the guideway. This can only be reliably determined by means of experimentation.

6.6.1 Short Strokes with MINISLIDE

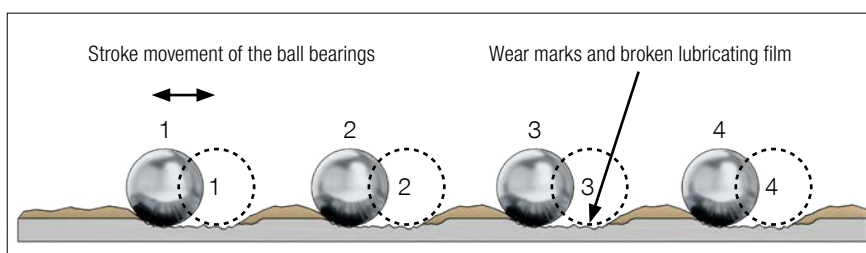

The stroke length of the guideway is so low that the rolling elements cannot pass the position of the next rolling element. As a result, local wear marks form on the tracks. Overstraining the tracks with short strokes leads to material damage which inevitably leads to the loss of preload. The accuracy of the guideway can consequently be reduced which can lead to premature failure.

Additionally, high-frequency strokes can break the lubricating film, further exacerbating wear. With suitable lubricants and regular strokes along the entire stroke length, better lubrication can be achieved, delaying the effects of material wear.

6.6.2 Short Strokes with MINIRAIL and MINISCALE PLUS

In the starting position (1), only the ball bearings directly under load are lubricated. Once the carriage moves to the right (2), a section of the ball bearings takes up the lubricant via the guideway. Only once position 3 has been reached will all of the ball bearings and all four corners of the ball recirculation be lubricated.

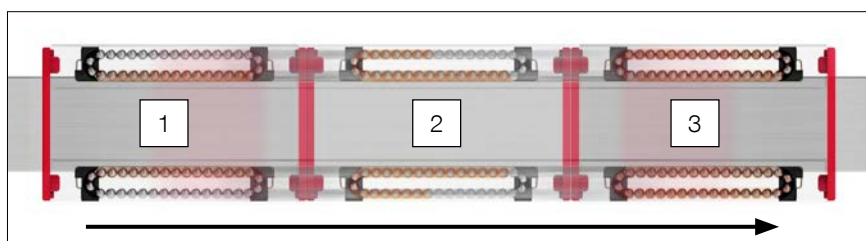

A short stroke is when the stroke of the carriage corresponds to less than twice its length. This can lead to damage, particularly in the redirection unit. Regular lubricating strokes along the entire stroke length at a minimum of twice the length of the carriage ensure better lubricant distribution, protecting the guideway from premature wear.

We recommend using LUBE-S long-term lubrication for short strokes. (see chapter 8.1).

7 MINIRAIL Product Overview

MINIRAIL are highly accurate miniature profiled linear guideways with ball bearings. Their precision, robustness, innovative design and strength are second to none.

The range includes the standard rail widths of 7, 9, 12 and 15 as well as wider widths of 14, 18, 24 and 42. The carriages are available in four lengths: MNNS (short), MNN (standard), MNNL (long) and MNNXL (extra long).

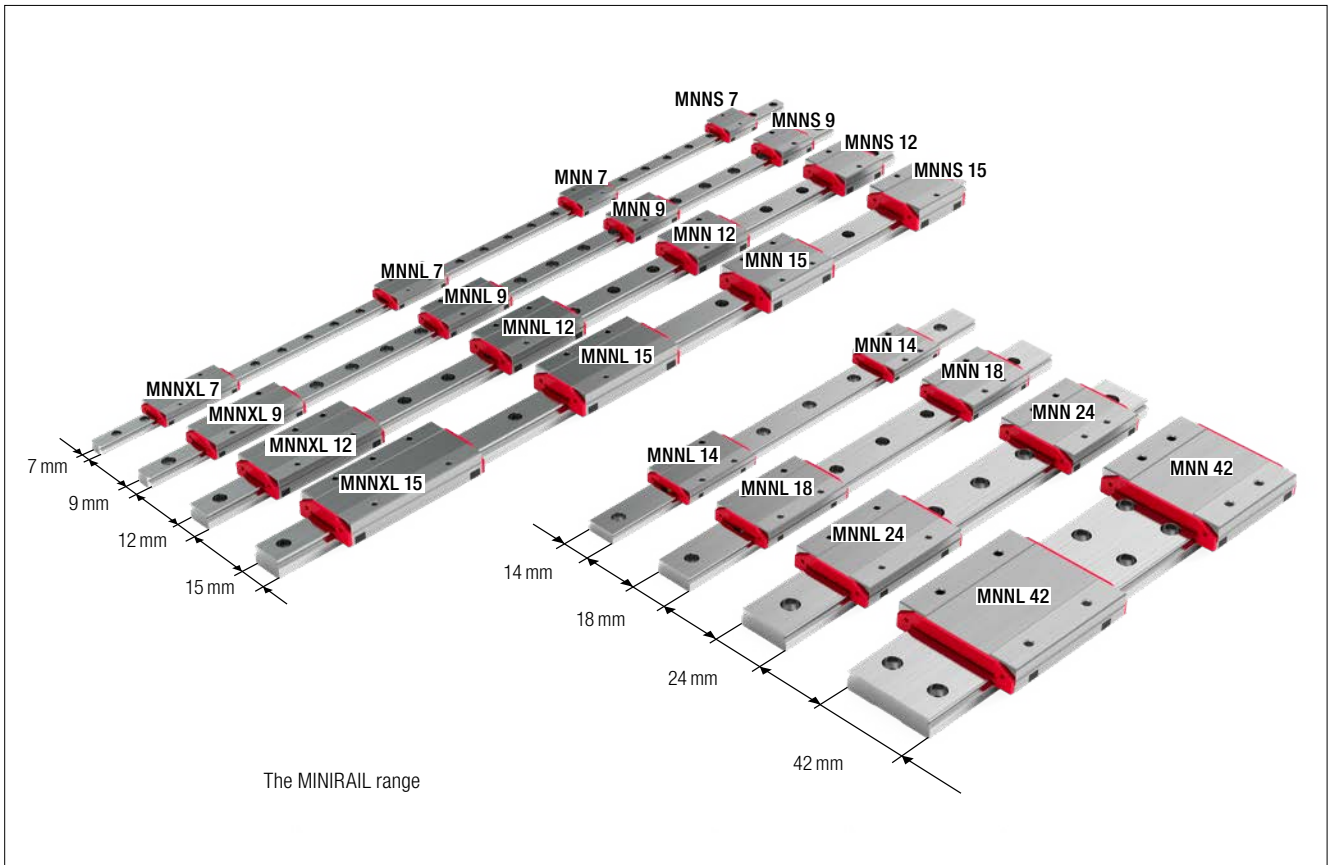

10 MINISCALE PLUS Product Overview

This extraordinary innovation combines «movement» with «measuring» in a highly integrated design. MINISCALE PLUS makes the most compact applications possible and simplifies assembly and installation significantly.

MINISCALE PLUS is based on our MINIRAIL guideways and is available for our entire product range.

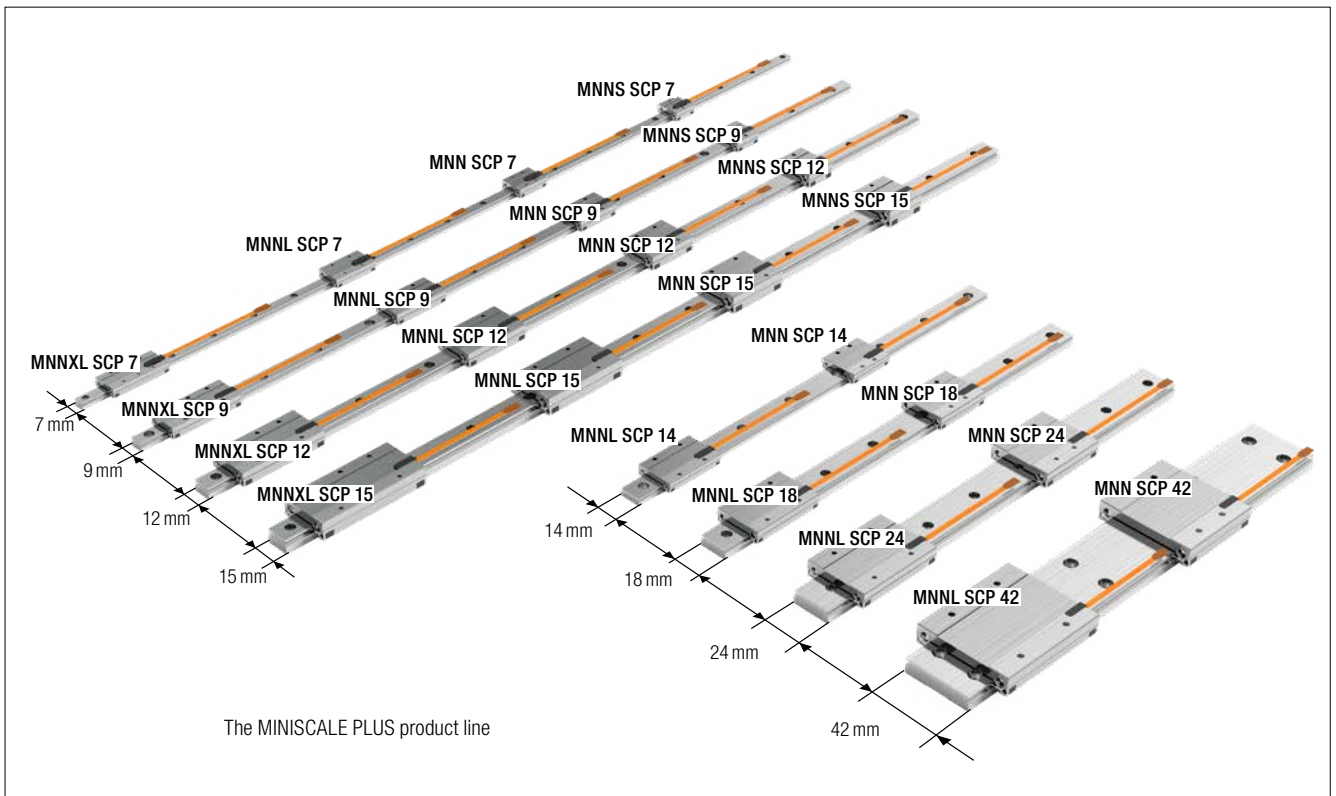

10 MINISCALE PLUS Product Overview

10.1 Product Characteristics

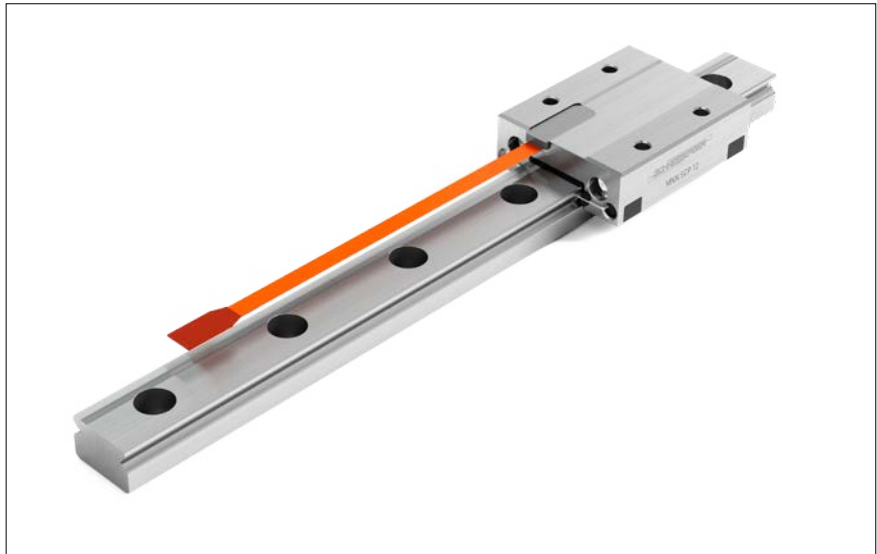

MINISCALE PLUS

Highly integrated, compact design

- The measuring sensor is integrated into the carriage and requires no additional installation space

Minimal design planning

- The costs of a separate distance measuring system are not required

Quick and easy installation

- MINISCALE PLUS is delivered ready-to-install
- No need for additional components and special mounting (as would be required for a glass scale, for example)
- Distance measurements do not have to be adjusted
- Mounting a measuring scale is not necessary

Consistently high level of accuracy

- Very smooth running with no rolling element pulsation
- The position measurement is performed directly at the point of friction
This simplifies the controlling of micromovements and dynamic motions
- No hysteresis or positioning errors compared to recirculating ball screws with rotary encoders
- Measurement is carried out directly during the work process
This reduces Abbe errors
- High Repeatability
- Immune to vibration and shock as a single assembly

High level of reliability and long service life

- MINISCALE PLUS is based on the successful MINIRAIL design.
- The dimensional scale is marked directly on the guideway. The sensor is perfectly integrated into the carriage and sealed

10 MINISCALE PLUS Product Overview

10.2 Technical Information and Modifications

10.2.1 Performance Parameters of MINISCALE PLUS

| | | | |
|--|---|--|-----------------------------|
| Max. acceleration | 300 m/s ² | | |
| Max. speed | 5 m/s analog, 3.2 m/s digital | | |
| Preload classes | V1 | Preload 0 to 0.03 C | (C = dynamic load capacity) |
| Accuracy classes | G1 | | |
| Materials - guideways, carriages, ball bearings - ball recirculation | Stainless, through-hardened steel POM | | |
| Areas of application - temperature range ⁽¹⁾ - vacuum - humidity - cleanroom | -40 °C to +80 °C (-40 °F to +176 °F) On request 10 % to 70 % (non-condensing) Cleanroom class ISO 7 or ISO 6 (in accordance with ISO 14644-1) | | |
| Resolution | TTL output | 0.1 µm ⁽³⁾ | (optional: 1 µm / 10 µm) |
| Accuracy ⁽²⁾ | 1000 mm | +/- 5 µm ⁽⁴⁾ | |
| Repeatability ⁽²⁾ | Unidirectional Bidirectional | +/- 0.1 µm +/- 0.2 µm | (with resolution of 0.1 µm) |
| Dimensional scale | Pitch Max. length Coefficient of expansion | 100 µm 1000 mm 11.7 x 10 ⁻⁶ K ⁻¹ | |
| Supply voltage | 5 V DC +/- 5 % | | |
| Current consumption (typical) | 60 mA (analog) / 90 mA (digital) | | |
| Output signal | Analog: 1 Vpp (at 120 Ω) Digital: TTL in accordance with RS 422 standard | | |
| Source format | Differential sin/cos analog signals with reference pulse or Differential, interpolated digital signals (A, B, R) The reference signal is synchronised with the incremental signals | | |

⁽¹⁾ The standard lubrication covers a temperature range from -20 °C to +80 °C. Lubricants for other temperatures are available upon request from SCHNEEBERGER.

⁽²⁾ The values apply to a room temperature of 20 °C (68 °F).

⁽³⁾ Note the high signal frequencies at high resolution and high speed.

⁽⁴⁾ Linearity protocol available on request

10 MINISCALE PLUS Product Overview

10.2.2 Dimension Tables, Load Capacities, and Moment Loads for Standard Width MINISCALE PLUS

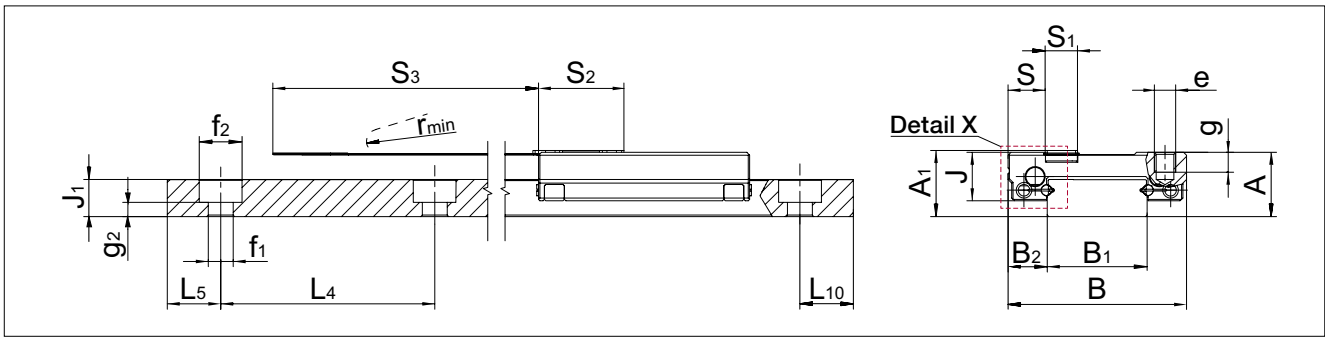

Please contact SCHNEEBERGER for applications with a single MINISCALE PLUS carriage type MNNS 7, 9, 12 or 15.

Detail X

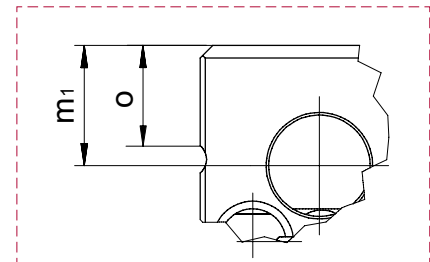

| | Name | Standard size 7 | | | | | Standard size 9 | | | | |
|--------------------------------------|---------------------------------|-----------------|----------|---------|----------|-----------|-----------------|----------|---------|----------|-----------|
| | | Guideway | MNNS SCP | MNN SCP | MNNL SCP | MNNXL SCP | Guideway | MNNS SCP | MNN SCP | MNNL SCP | MNNXL SCP |
| Dimensions (mm) | A | 8 | | | | | 10 | | | | |
| | A ₁ | 9.2 | | | | | 10 | | | | |
| | B | 17 | | | | | 20 | | | | |
| | B ₁ | 7 | | | | | 9 | | | | |
| | B ₂ | 5 | | | | | 5.5 | | | | |
| | J | 6.5 | | | | | 8 | | | | |
| | J ₁ | 4.5 | | | | | 5.5 | | | | |
| | L ₁ | | - | 8 | 13 | 20 | | - | 10 | 16 | 26 |
| | L ₂ | | - | - | - | 10 | | - | - | - | 13 |
| | L ₄ | 15 | | | | | 20 | | | | |
| | L ₅ /L ₁₀ | 5 | | | | | 7.5 | | | | |
| | L ₆ | | 16.1 | 22.1 | 29.6 | 38.6 | | 19 | 29 | 37 | 47 |
| | N | | 12 | | | | | 15 | | | |
| | e | | M2 | | | | | M3 | | | |
| | f ₁ | 2.4 | | | | | 3.5 | | | | |
| | f ₂ | 4.2 | | | | | 6 | | | | |
| | g | | 2.5 | | | | | 3 | | | |
| | g ₂ | 2.2 | | | | | 2 | | | | |
| | m ₁ | | 3.1 | | | | | 3.8 | | | |
| | o | | 2.5 | | | | | 3.1 | | | |
| s | | 3.6 | | | | | 4.2 | | | | |
| s ₁ | | 5.5 | | | | | 5.5 | | | | |
| s ₂ | | 13.5 | | | | | 13.5 | | | | |
| s ₃ | | 75 | | | | | 75 | | | | |
| r _{min} | | 2 | | | | | 2 | | | | |
| Load capacity (N) | C ₀ | | 935 | 1560 | 2340 | 3275 | | 1385 | 2770 | 3880 | 5270 |
| | C | | 645 | 925 | 1230 | 1550 | | 1040 | 1690 | 2140 | 2645 |
| Torque (Nm) | M _{0L} | | 3.4 | 5.6 | 8.4 | 11.8 | | 6.5 | 12.9 | 18.1 | 24.5 |
| | M _{0L} | | 1.6 | 4.3 | 9.3 | 18 | | 2.8 | 10.2 | 19.4 | 35.1 |
| | M ₀ | | 2.3 | 3.3 | 4.4 | 5.6 | | 4.8 | 7.9 | 9.9 | 12.3 |
| | M _L | | 1.1 | 2.5 | 4.9 | 8.5 | | 2.1 | 6.2 | 10.7 | 17.6 |
| Weights guideway (g/m), carriage (g) | | 216 | 9 | 13 | 18 | 23 | 309 | 16 | 24 | 31 | 40 |

10 MINISCALE PLUS Product Overview

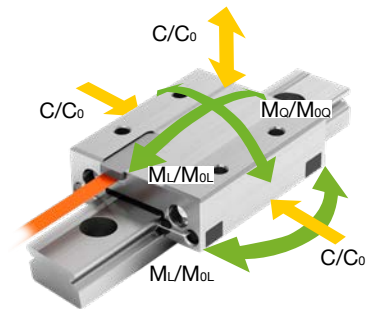
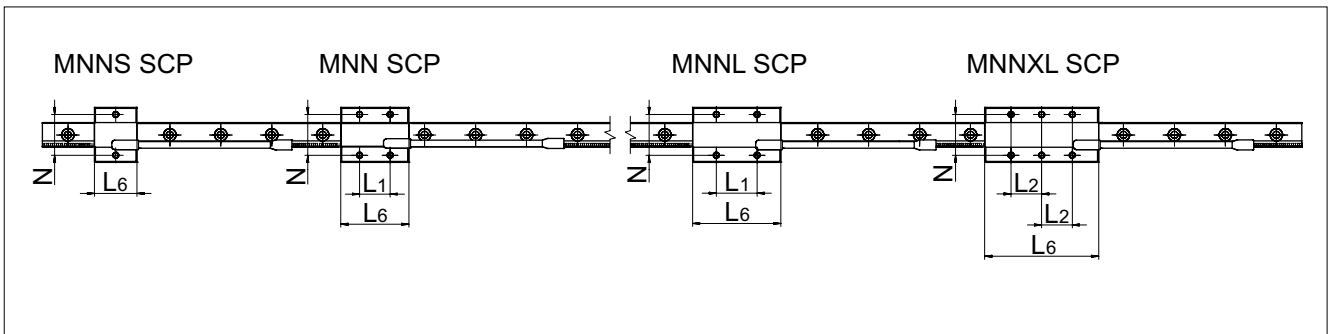

| | | Name | Standard size 12 | | | | Standard size 15 | | | | |
|--------------------------------------|--|--|---------------------|----------|---------|----------|---------------------|----------|----------|---------|----------|
| | | | Guideway | MNNS SCP | MNN SCP | MNNL SCP | MNNXL SCP | Guideway | MNNS SCP | MNN SCP | MNNL SCP |
| Dimensions (mm) | A | System height | 13 | | | | 16 | | | | |
| | A ₁ | System height with sensor | 27 | | | | 32 | | | | |
| | B | System width | 12 | 15 | | | | 15 | | | |
| | B ₁ | Rail width | 7.5 | | | | 8.5 | | | | |
| | B ₂ | Distance between reference surfaces | 10 | | | | 12 | | | | |
| | J | Carriage height | 7.5 | 9.5 | | | | 9.5 | | | |
| | J ₁ | Rail height | - | | | | - | | | | |
| | L ₁ | Longitudinal spacing of attachment holes | - | 15 | 20 | 30 | - | 20 | 25 | 40 | |
| | L ₂ | Longitudinal spacing of attachment holes | - | - | - | 15 | - | - | - | 20 | |
| | L ₄ | Spacing of attachment holes | 25 | 40 | | | | 40 | | | |
| | L ₅ /L ₁₀ | Position of first and last attachment hole | 10 | 15 | | | | 15 | | | |
| | L ₆ | Carriage length (steel body) | 20.9 33.4 43.4 55.9 | | | | 28.7 40.7 55.7 70.7 | | | | |
| | N | Lateral attachment hole spacing | 20 | | | | 25 | | | | |
| | e | Thread | M3 | | | | M3 | | | | |
| | f ₁ | Hole diameter | 3.5 | 3.5 | | | | 3.5 | | | |
| | f ₂ | Countersink diameter | 6 | 6 | | | | 6 | | | |
| | g | Thread depth | 3.5 | | | | 4 | | | | |
| | g ₂ | Step drilling height | 3 | 5 | | | | 5 | | | |
| | m ₁ | Position of lubrication holes | 4.75 | | | | 5.55 | | | | |
| | o | Reference face height | 3.9 | | | | 4.9 | | | | |
| s | Distance from sensor | 6.7 | | | | 8.3 | | | | | |
| s ₁ | Sensor width | 5.5 | | | | 5.5 | | | | | |
| s ₂ | Sensor length | 13.5 | | | | 13.5 | | | | | |
| s ₃ | Length of the flexible printed circuit board | 75 | | | | 75 | | | | | |
| r _{min} | Permitted radius | 2 | | | | 2 | | | | | |
| Load capacity (N) | C ₀ | Static load capacity | 1735 | 3900 | 5630 | 7800 | 3120 | 5620 | 8740 | 11855 | |
| | C | Dynamic load capacity ($\cong C_{100}$) | 1420 | 2510 | 3240 | 4070 | 2435 | 3680 | 5000 | 6200 | |
| Torque (Nm) | M ₀₀ | Permissible lateral static torque | 10.6 | 23.8 | 34.4 | 47.6 | 23.7 | 42.7 | 66.4 | 90.1 | |
| | M _{0L} | Permissible longitudinal static torque | 3.6 | 16.3 | 32.9 | 61.8 | 9.4 | 28.1 | 65.5 | 118.6 | |
| | M ₀ | Permissible lateral dynamic torque | 8.7 | 15.3 | 19.8 | 24.8 | 18.5 | 27.9 | 38.1 | 47.1 | |
| | M _L | Permissible longitudinal dynamic torque | 3 | 10.4 | 18.9 | 32.2 | 7.3 | 18.4 | 37.6 | 62 | |
| Weights guideway (g/m), carriage (g) | | 598 | 29 | 47 | 63 | 81 | 996 | 56 | 81 | 114 | 146 |

10 MINISCALE PLUS Product Overview

10.2.3 Dimension Tables, Load Capacities and Moment Loads for Wider Width MINISCALE PLUS

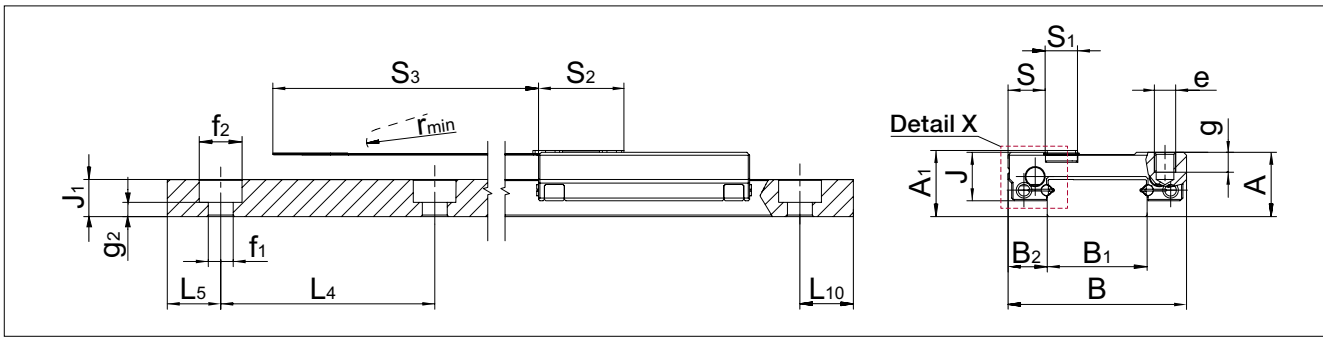

Detail X

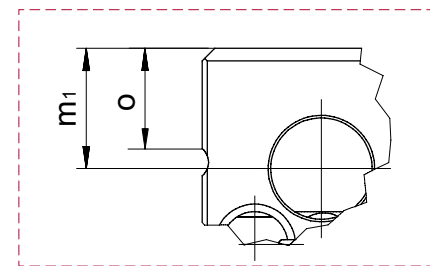

| Name | | Wide size 14 | | Wide size 18 | | | |
|--------------------------------------|---------------------------------|--------------|---------|--------------|----------|---------|-----------|
| | | Guideway | MNN SCP | MINNL SCP | Guideway | MNN SCP | MINNL SCP |
| Dimensions (mm) | A | 9 | | 12 | | | |
| | A ₁ | 10 | | 30 | | | |
| | B | 25 | | 6 | | | |
| | B ₁ | 14 | 18 | | 8.5 | | |
| | B ₂ | 5.5 | | 24 | | | |
| | J | 6.8 | | - | | | |
| | J ₁ | 5.2 | 7 | | M3 | | |
| | L ₁ | 10 | | 19 | | | |
| | L ₂ | - | | - | | | |
| | L ₄ | 30 | 30 | | 37 | | |
| | L ₅ /L ₁₀ | 10 | 10 | | 47 | | |
| | L ₆ | 29.6 | | 38.6 | | | |
| | L ₈ | - | | - | | | |
| | N | 19 | | 21 | | | |
| | e | M3 | | M3 | | | |
| | f ₁ | 3.5 | 3.5 | | 3 | | |
| | f ₂ | 6 | 6 | | - | | |
| | g | 2.8 | | 3 | | | |
| | g ₂ | 2 | 2.5 | | - | | |
| | m ₁ | 3.3 | | 4.3 | | | |
| | o | 2.2 | | 3.1 | | | |
| | s | 5.2 | | 5.8 | | | |
| | s ₁ | 5.5 | | 5.5 | | | |
| s ₂ | 13.5 | | 13.5 | | | | |
| s ₃ | 75 | | 75 | | | | |
| r _{min} | 2 | | 2 | | | | |
| Load capacity (N) | C ₀ | 2340 | 3275 | 3880 | 5270 | | |
| | C | 1230 | 1550 | 2140 | 2645 | | |
| Torque (Nm) | M ₀₀ | 16.6 | 23.3 | 35.5 | 48.2 | | |
| | M _{0L} | 9.3 | 18 | 19.4 | 35.1 | | |
| | M ₀ | 8.7 | 11 | 19.6 | 24.2 | | |
| | M _L | 4.9 | 8.5 | 10.7 | 17.6 | | |
| Weights guideway (g/m), carriage (g) | | 518 | 25 | 33 | 915 | 47 | 60 |

10 MINISCALE PLUS Product Overview

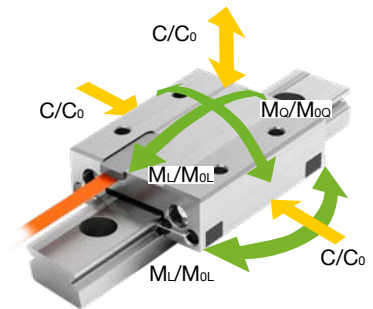
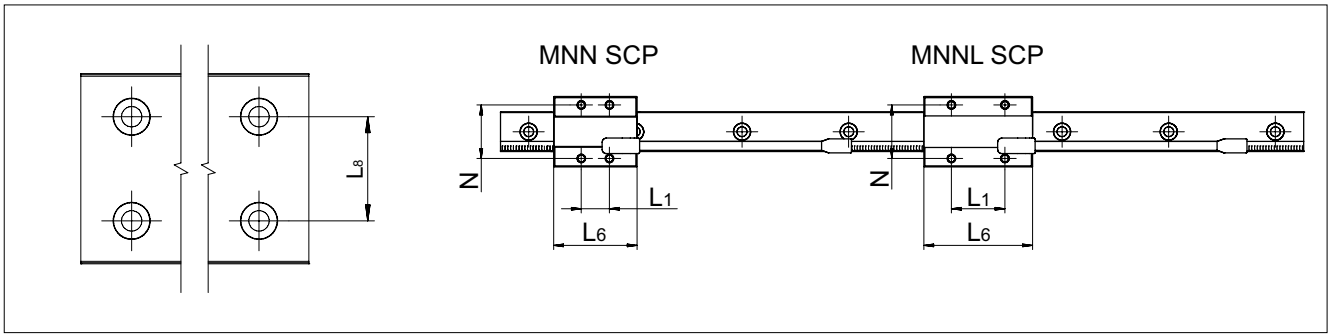

| Name | | Wide size 24 | | | Wide size 42 | | | |
|--------------------------------------|---------------------------------|--|----------------------|----------|--------------|---------|----------|--|
| | | Guideway | MNN SCP | MNNL SCP | Guideway | MNN SCP | MNNL SCP | |
| Dimensions (mm) | A | System height | | 14 | | 16 | | |
| | A ₁ | System height with sensor | | 40 | | 60 | | |
| | B | System width | | 8 | | 9 | | |
| | B ₁ | 24 | Rail width | | 42 | 12 | | |
| | B ₂ | Distance between reference surfaces | | 10 | | 12 | | |
| | J | Carriage height | | 15 | | 15 | | |
| | J ₁ | 8.5 | Rail height | | 9.5 | 20 | | |
| | L ₁ | Longitudinal spacing of attachment holes | | 15 | 28 | 35 | | |
| | L ₂ | Longitudinal spacing of attachment holes | | - | - | - | | |
| | L ₄ | Spacing of attachment holes | | 40 | | 40 | | |
| | L ₅ /L ₁₀ | Position of first and last attachment hole | | 15 | | 15 | | |
| | L ₆ | Carriage length (steel body) | | 43.4 | 55.9 | 52.7 | 70.7 | |
| | L ₈ | Lateral attachment hole spacing | | - | | 23 | | |
| | N | Lateral attachment hole spacing | | 28 | | 45 | | |
| | e | Thread | | M3 | | M4 | | |
| | f ₁ | 4.5 | Hole diameter | | 4.5 | | 4.5 | |
| | f ₂ | 8 | Countersink diameter | | 8 | | 8 | |
| | g | Thread depth | | 3.5 | | 4.5 | | |
| | g ₂ | 4 | Step drilling height | | 5 | | 5 | |
| | m ₁ | Position of lubrication holes | | 4.75 | | 5.5 | | |
| | o | Reference face height | | 3.9 | | 4.9 | | |
| | s | Distance from sensor | | 7.8 | | 8.8 | | |
| | s ₁ | Sensor width | | 5.5 | | 5.5 | | |
| | s ₂ | Sensor length | | 13.5 | | 13.5 | | |
| | s ₃ | Length of the flexible printed circuit board | | 75 | | 75 | | |
| | r _{min} | Permitted radius | | 2 | | 2 | | |
| Load capacity (N) | C ₀ | Static load capacity | | 5630 | 7800 | 8110 | 11855 | |
| | C | Dynamic load capacity ($\cong C_{100}$) | | 3240 | 4070 | 4750 | 6200 | |
| Torque (Nm) | M ₀₀ | Permissible lateral static torque | | 68.2 | 94.4 | 171.2 | 250.2 | |
| | M _{0L} | Permissible longitudinal static torque | | 32.9 | 61.8 | 56.8 | 118.6 | |
| | M ₀ | Permissible lateral dynamic torque | | 39.2 | 49.3 | 100.3 | 130.8 | |
| | M _L | Permissible longitudinal dynamic torque | | 18.9 | 32.2 | 33.3 | 62 | |
| Weights guideway (g/m), carriage (g) | | 1476 | 84 | 109 | 2828 | 169 | 231 | |

10 MINISCALE PLUS Product Overview

10.2.4 MINISCALE PLUS Components and Working Method

MINISCALE PLUS is an optical, incremental measuring system that consists of the MINIRAIL guide system and the following additional components:

- A** Dimensional scale on the guide rail
- B** Optical sensor on the carriage
- C** Flexible Sensor Print (must not be exposed to dynamic loads)
- D** Interface module

The control cable **E** with D-Sub 9 connector must be supplied by the customer and be a flexible cable where necessary.

There are various structural types of interface modules available. These are described in section „Interface module“.

With a flexible flat cable (Flat Flex Cable, abbreviated: FFC), which is inserted between the flexible sensor print and the interface module, the interface module can be positioned flexibly. The FFC cables are suitable for dynamic loads. (You can find more information about this in section 10.2.8)

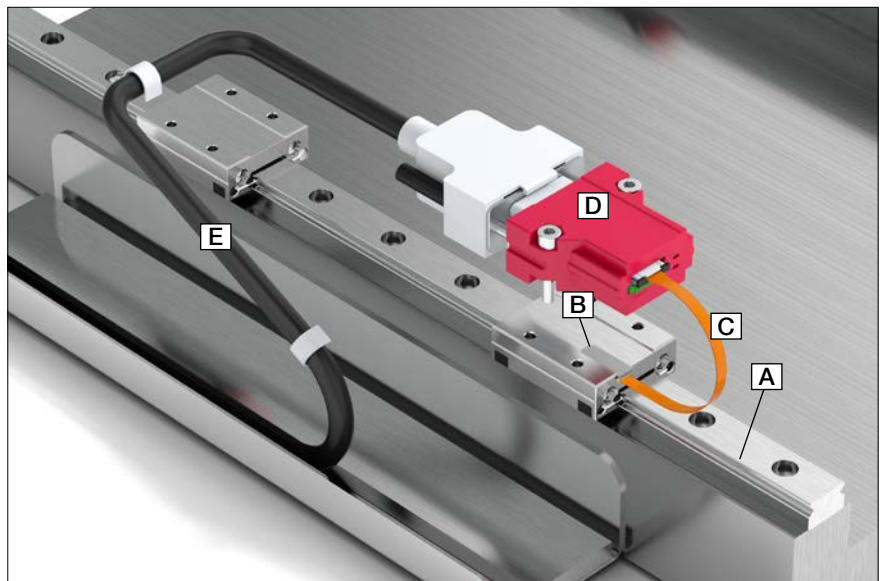

Axis with MINIRAIL, MINISCALE PLUS and interface module

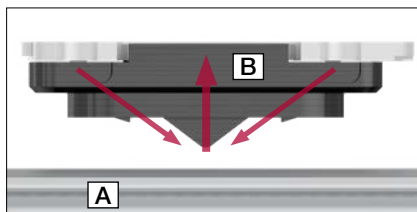

Sensor principle

- A** Dimensional scale on guideway
- B** Sensor in carriage

Dimensional scale and optical sensor

The high-precision dimensional scale is part of the hardened guideway's surface with a scale increment of 100 μm . Two LEDs in the sensor illuminate the dimensional scale. Light-dark fields form because of the illumination of the various structured areas on the dimensional scale. These optical signals are detected by the sensor and converted into electrical signals. The raw signals supplied by the sensor are processed by the interface module.

The level of illumination provided by the LEDs is actively controlled. This can counteract the aging of the system and impurities on the dimensional scale are also compensated for.

10 MINISCALE PLUS Product Overview

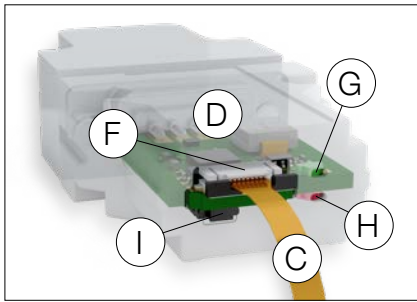

Components of the interface module

Interface module

The raw signals are processed by the interface module and converted to standard output signals. Analog or digital interface modules are available.

Ensure the ZIF connector **F** is accessible and the LED displays (**G** and **H**) on the interface module are clearly visible. Unlike the analog interface, the digital interface includes a compensation key **I**, which must also be accessible.

- C** Flexible Sensor Print
- D** Electronics (in various structural types)
- F** ZIF connector
- G** Green LED (operating voltage)
- H** Red LED (error indicator)
- I** Compensation key (only on digital interface module)

The interface modules are available in the following structural types:



With housing
With D-Sub 9 connector

Order designation: MG
(Standard)

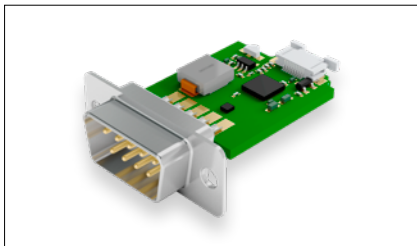
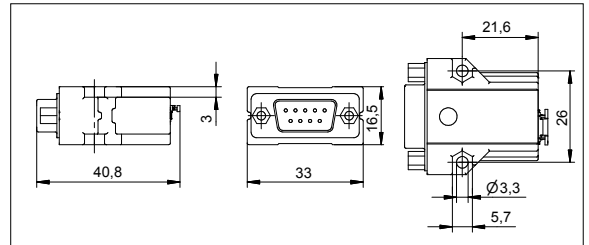

Without housing
With D-Sub 9 connector

Order designation: OG

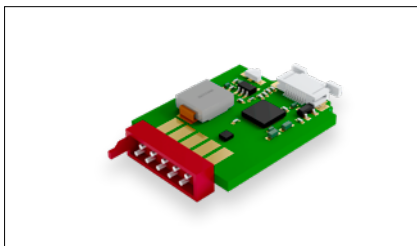
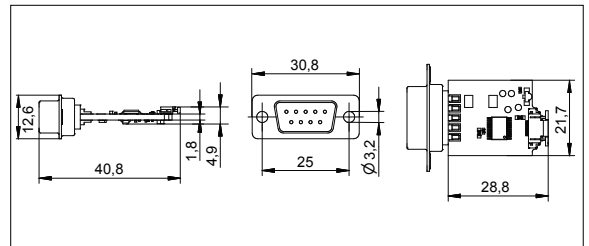

Without housing
With Micro Match connector
(for plug-in assembly on
an electronics board)

Order designation: MM

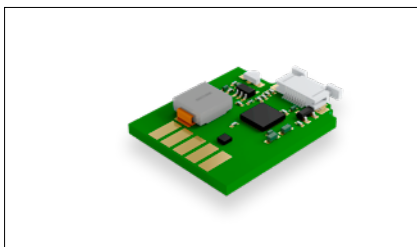
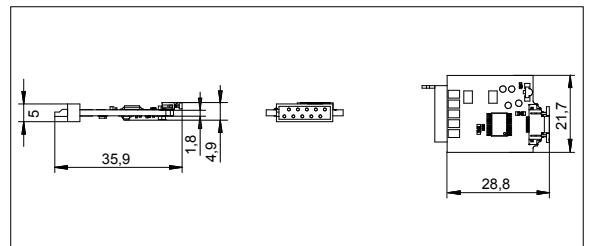

Without housing
Without connector
With solder terminals

Order designation: NL

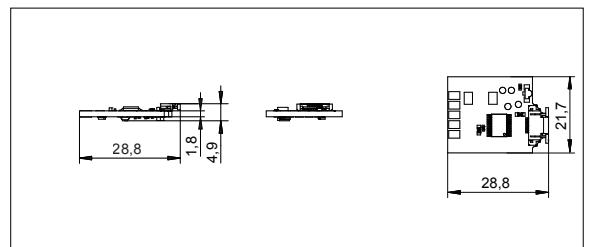

For customers with expertise in electronics, it is also possible to assemble their own digital interface module and integrate it into their own electronics, in consultation with SCHNEEBERGER.

Order designation: KI

10.2.5 Signal Processing

Further information about signal processing is available from the download section of our website www.schneeberger.com.

Analog output format:

Differential, sin/cos analog signals with reference pulse 1 Vpp (at 120 Ω).

The incremental signals sine and cosine are shifted 90° and correlated with the markings on the encoded scale. An electrical signal period (360°) corresponds precisely to the scale increment of the dimensional scale, which is 100 μm.

The reference pulse always marks electronically the same section of the path of the sine and cosine signals. The point of intersection of the two signals within the reference pulse therefore marks a precisely defined position on the dimensional scale.

The sine signal either lags behind the cosine signal or occurs before it, depending on the direction of movement.

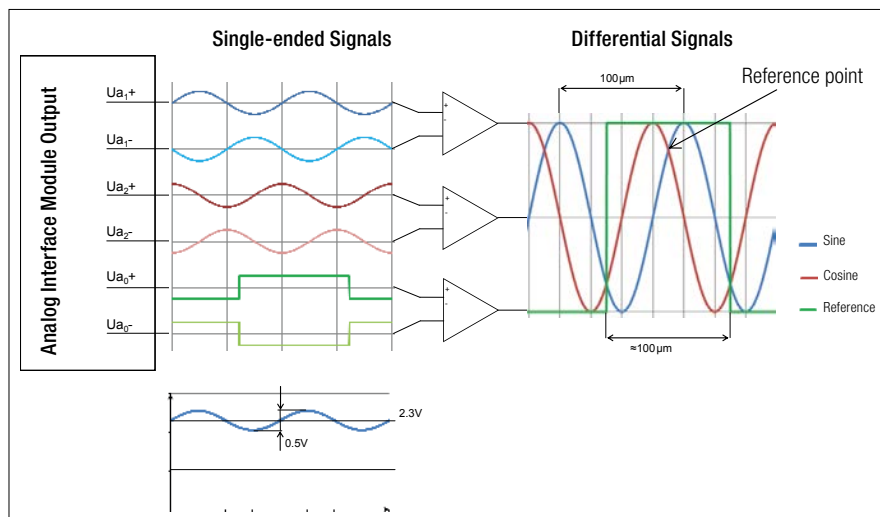

10 MINISCALE PLUS Product Overview

Digital output format:

Differentially interpolated digital signals with reference pulse (A, B, R) TTL signal (RS422).

The digital interface module both processes the raw signal and interpolates the processed analog signal. The interpolation achieves a resolution of 100 nm.

The digital signal waveform consists of an A and B signal. The spacing between the two edges of signals A and B correspond exactly to a distance of 100 nm. The 100 μm increments of the encoder scale are consequently divided into 1000 sections of 100 nm by means of interpolation. The A signal either lags behind the B signal or occurs before it, depending on the direction of movement.

The reference pulse is as wide as the spacing between the two signal edges of signals A and B (100 nm).

The edges of the incremental and reference signals are synchronised.

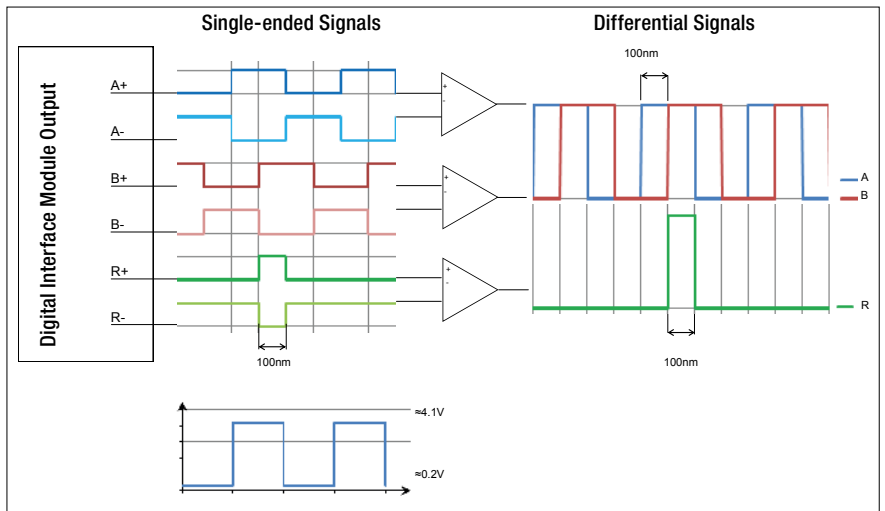

10.2.6 Incremental track

In standard versions, the incremental track is continued over the entire guideway length.

The position and length can be adapted as per the customer's request.

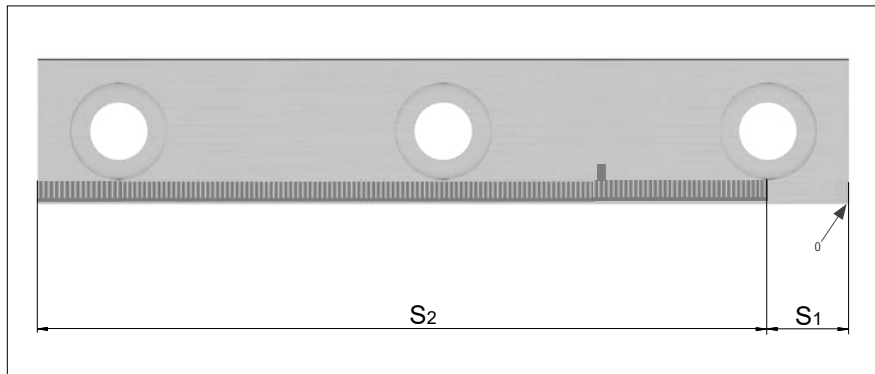

S1 = Start of incremental track

S2 = Length of incremental track

Restrictions:

- For analog MINISCALE PLUS guideways, the length of the incremental track (S_2) must be at least 30 mm

10.2.6 Reference Marks

Incremental measuring systems cannot determine the exact position when switched on. For this reason the reference track is added alongside the incremental track. One or multiple reference points can be marked on the reference track.

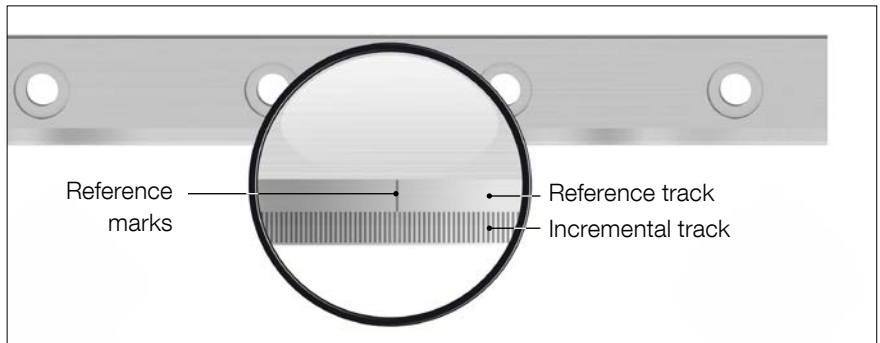

MINISCALE PLUS guideway with dimensional scale

Standard version

The following reference position is defined as standard for all sizes:

- Referencing in the centre of the first and second fixing hole

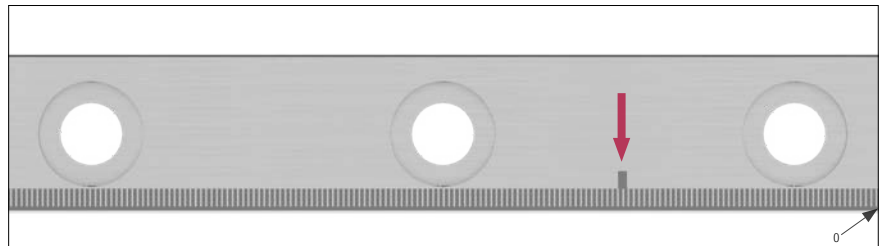

Standard position of the reference marks for all sizes

Special versions

Any number of reference marks can be chosen at any position along the reference track. It is necessary for the reference marks to be synchronised with the dimensional scale. Specifically this means that the reference marks can only be placed in multiples of 0.1 mm, since the pitch of the dimensional scale is 0.1 mm. A minimum distance of 1.5 mm between the reference marks should be maintained. Additionally, the distance between the end of the incremental track and the reference mark must be at least 2 mm.

Restrictions:

- The attachment holes on guideways of type 7 and 9 are located on the reference track. The reference marks must therefore be BETWEEN the attachment holes for both of these sizes.
- When specifying the reference mark(s), ensure they can be seen by the carriage's sensor.

10 MINISCALE PLUS Product Overview

10.2.7 Analog (1VSS) and Digital (TTL) Interface Module Pin Connections

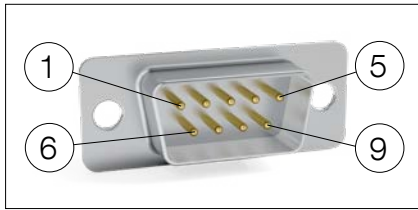

Pin connections of D-Sub 9 connector at the interface module

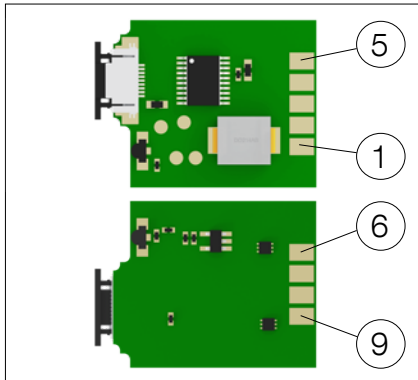

Pin connections at the interface module with solder terminals

Male 9-pin D-Sub connector or solder terminals:

| Pin | Analog Signal | Digital Signal | Description |
|-----|---------------|----------------|----------------------------|
| 1 | Ua1 - | A - | Quadrature signal |
| 2 | 0V | 0V | Ground |
| 3 | Ua2- | B - | Quadrature signal |
| 4 | ERR NOT | ERR NOT | Error signal (Low = Error) |
| 5 | Ua0 - | R - | Reference signal |
| 6 | Ua1 + | A + | Quadrature signal |
| 7 | + 5V DC | + 5V DC | Supply voltage |
| 8 | Ua2 + | B + | Quadrature signal |
| 9 | Ua0 + | R + | Reference signal |

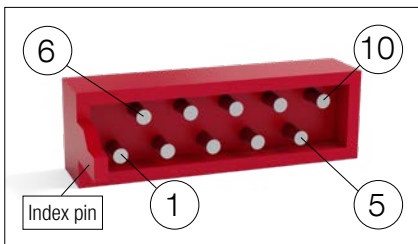

Pin connections of Micro Match connector at the interface module

Male 10-pin Micro Match connector:

| Pin | Analog Signal | Digital Signal | Description |
|-----|---------------|----------------|----------------------------|
| 1 | nc | nc | |
| 2 | Ua1 + | A + | Quadrature signal |
| 3 | + 5V DC | + 5V DC | Supply voltage |
| 4 | Ua2 + | B + | Quadrature signal |
| 5 | Ua0 + | R + | Reference signal |
| 6 | Ua1 - | A - | Quadrature signal |
| 7 | 0V | 0V | Ground |
| 8 | Ua2 - | B - | Quadrature signal |
| 9 | ERR NOT | ERR NOT | Error signal (Low = Error) |
| 10 | Ua0 - | R - | Reference signal |

10 MINISCALE PLUS Product Overview

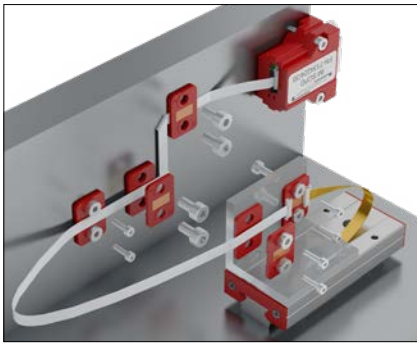

Installation example with FFC extension

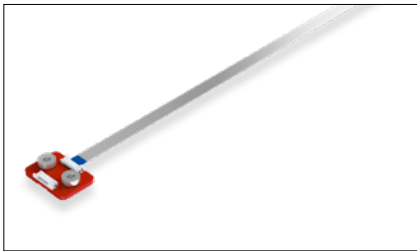

FFC cable with adapter

10.2.8 Extensions

Wherever the interface module cannot be mounted directly at the sensor, the extension kit can be used. A flexible flat cable (Flat Flex Cable, abbreviated: FFC) is used between the sensor print and the interface module.

This offers the following benefits:

- By moving the interface module, the mass of the moving system can be reduced by moving the interface module to a non-moving location.
- The shielded FFC cable included in the extension set is also designed to be dynamically loaded. The minimum recommended bending radius is 10 mm. In contrast, the flexible sensor print can only be installed statically.
- The FFC cable provides a low push force. This can be a benefit wherever a cable that can be used in a cable carrier is too rigid.
- The FFC cable can also be folded once during installation.

FFC cables are available in three lengths: 250 mm, 400 mm and 600 mm. An adapter board is delivered with the FFC extension cable.

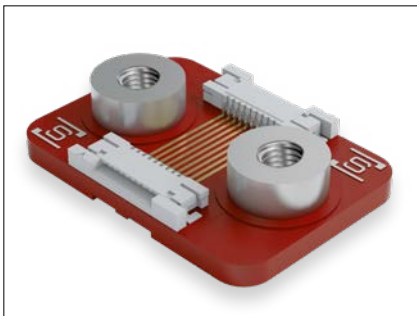

Adapter

It is used for the electrical connection between the sensor print and the extension cable. Two ZIF connectors are available on the adapter for this purpose.

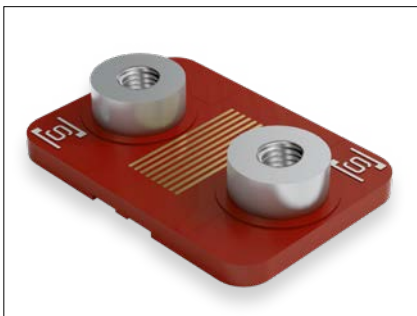
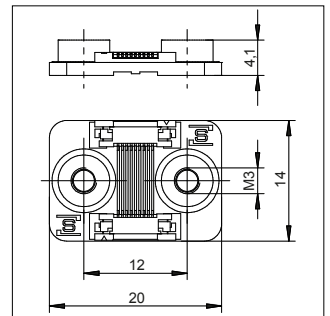

Clamp plate

Can be used for stress relief or to guide the FFC cable. Two M3 spacer sleeves are installed on the board.

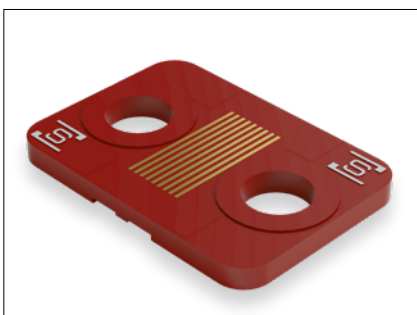
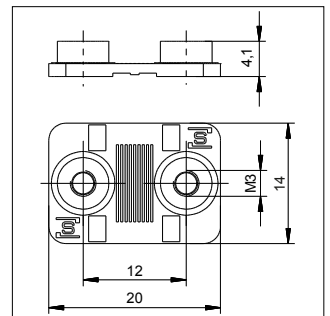

Base plate

Can be used as a base or for clamping the cable.

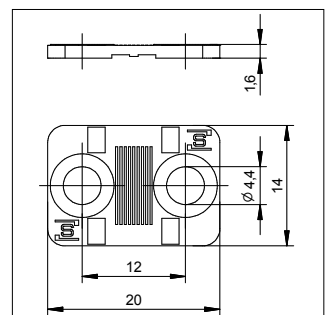

10.2.9 Lubrication

General

Lubrication is a design element and must therefore be defined during the development phase of a machine or application. If the lubrication is specified after design and construction is complete, this is likely to lead to operational difficulties. A carefully thought out lubrication concept is therefore a sign of a state-of-the-art and well devised design.

Parameters to be taken into account in selecting the lubricant include:

- Operating conditions (speed, acceleration, stroke, load, installation orientation)
- External influences (temperature, aggressive media or radiation, contamination, humidity, vacuum, cleanroom)
- Relubrication (Period of time, amount, compatibility)
- Compatibility (with other lubricants, with corrosion protection and with integrated materials such as plastic)

Technical and economic considerations determine the lubricant used.

The guideways should be kept free of cutting oils or water-soluble coolants as they thin or wash off the lubricant. In addition, coolants tend to stick when drying out. Lubricants with solid additives are not suitable.

Additional important information on lubrication is given in chapter 16.3.4.

11 MINISCALE PLUS Options

11.1 Push Force Defined (VD)

Demanding applications may only be possible if the guideway has a defined push force. These parameters can be defined by SCHNEEBERGER according to customer specifications. Carriages and guideways are then matched and delivered as a set.

11.2 Height-matched Carriages (HA)

In accuracy class G1, the maximum height deviation of the carriages is $\pm 10 \mu\text{m}$. This tolerance can be too large for certain configurations, for example when the distances among the individual carriages is too small, i.e. when the carriage spacing L_b is smaller than the carriage length L . In such cases, the tolerances can be reduced on a customer-specific basis.

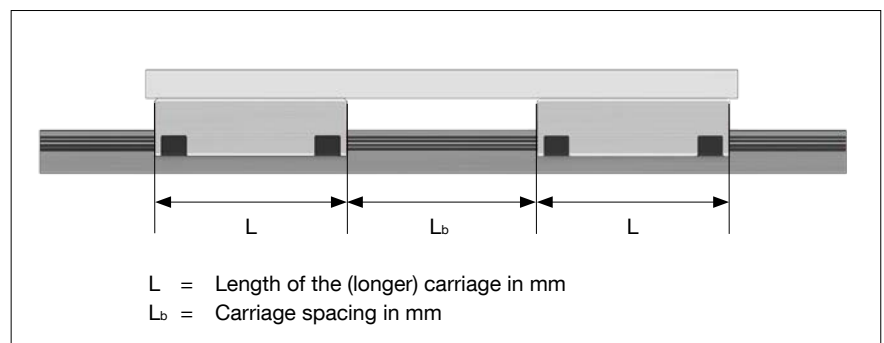

12 MINISCALE PLUS Accessories

12.1 MINISCALE PLUS Counter and Position Indicator

For simple applications, experimental or prototype setups, we recommend the USB counters from Heilig & Schwab GmbH & Co. KG. The following counters can be ordered directly from Heilig & Schwab GmbH & Co. KG (www.heilig-schwab.de).



1-axis USB counter

12.1.1 1-axis USB Counter

The USB counter allows a MINISCALE PLUS or similar incremental encoder with TTL, 1 Vpp, or 11 μ Ass signal output to be connected directly to a computer using a USB interface.

With the included driver software, the USB counter can be quickly and easily integrated into your application.



3-axis USB counter

12.1.2 3-axis USB Counter

The USB counter allows three MINISCALE PLUS or similar incremental encoders with TTL, or 1 Vpp signal output to be connected directly to a computer using a USB interface. Every counter input additionally has a latch signal input at its disposal.

With the included driver software, the USB counter can be quickly and easily integrated into your application.

16 Installation and Adjustment Guidelines for MINIRAIL and MINISCALE PLUS

16.2 Installation Methods

Different criteria must be taken into consideration when choosing an appropriate installation method and defining the number and arrangement of the lateral reference surfaces. These are:

16.2.1 Load

16.2.2 Accuracy

16.2.3 Installation time and engineering expense

16.2.4 Installation location and specifics

16.2.1 Load

Forces in the direction of tension/compression do not have any influence on the lateral reference surfaces. If side loads emerge which exceed the permitted lateral force, references and lateral clamping must be specified. Number and orientation depend on the forces that occur.

The reference surfaces should be arranged based on the direction of force of the main load. Lateral references should also be provided when vibration and impacts occur. They also increase the rigidity of the system.

16.2.2 Accuracy

Lateral reference surfaces are recommended if a high level of guideway accuracy is required. The references make installation easier and reduce the complexity involved in ensuring accuracy. The guideway accuracy is determined by the straightness of the reference surfaces and by the guide rail compression process and/or by the accuracy of the lateral clamping.

16.2.3 Installation Time and Engineering Expense

Reference surfaces make installation easier and reduce the complexity involved in aligning the guide rails.

With careful manual alignment of the guideway, it is possible to dispense with the need for lateral reference surfaces. When deciding on a method, the complexity of the installation should be carefully considered and compared with the design and technical manufacturing complexity.

16.2.4 Installation Location and Specifics

Reference surfaces and lateral clamping require additional installation space and access to the installation areas. It is therefore important to check whether the provided references and adjustments are compatible with the installation area in the machine.

Shown below are some typical installation methods which differ in terms of the number and orientation of the reference surfaces, the transferable lateral forces and the complexity of installation, and are intended to serve as a design aid.

16 Installation and Adjustment Guidelines for MINIRAIL and MINISCALE PLUS

Installation option 1

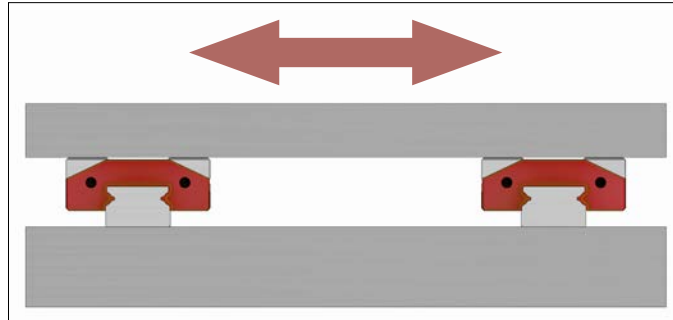

- No reference surfaces
- The forces are transferred by friction locking
- Long installation time and high engineering expense

Installation option 2

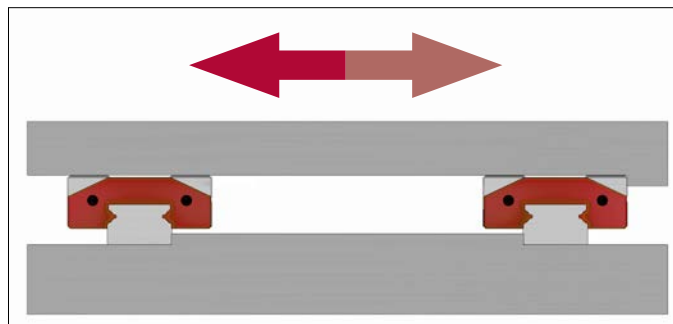

- Both guide rails with one reference
Carriage side with opposite reference
- Simple installation
- High lateral force absorption from one direction, e.g. for hanging installation

Installation option 3

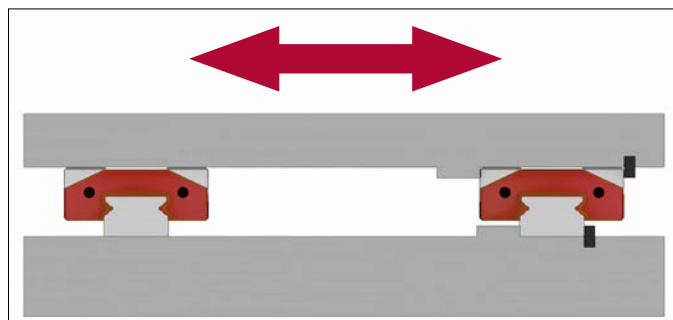

- A guide rail and carriage with reference and lateral clamping
- For high lateral forces from both directions (a guide rail with carriage will take the majority of the lateral force)
- Relatively simple installation

16 Installation and Adjustment Guidelines for MINIRAIL and MINISCALE PLUS

16.3 Preparing for the Installation

16.3.1 Required Tools and Equipment

- Oil stone
- Lubricant
- Torque wrench
- Fastening screws

16.3.2 Preparing the Reference Surfaces

- Check reference surfaces of the machine bed and mounting plate for shape and position accuracy.
- Clean all reference surfaces thoroughly. Remove ridges and surface irregularities with an oil stone.
- Use mineral spirits or rubbing alcohol to clean the reference and supporting surfaces of guideways and carriages. Do not use paint thinner!
- Clean dirty guideways with a soft, lint-free cloth. Do not use compressed air!
- Lightly oil the reference surfaces on the guideways and carriages.

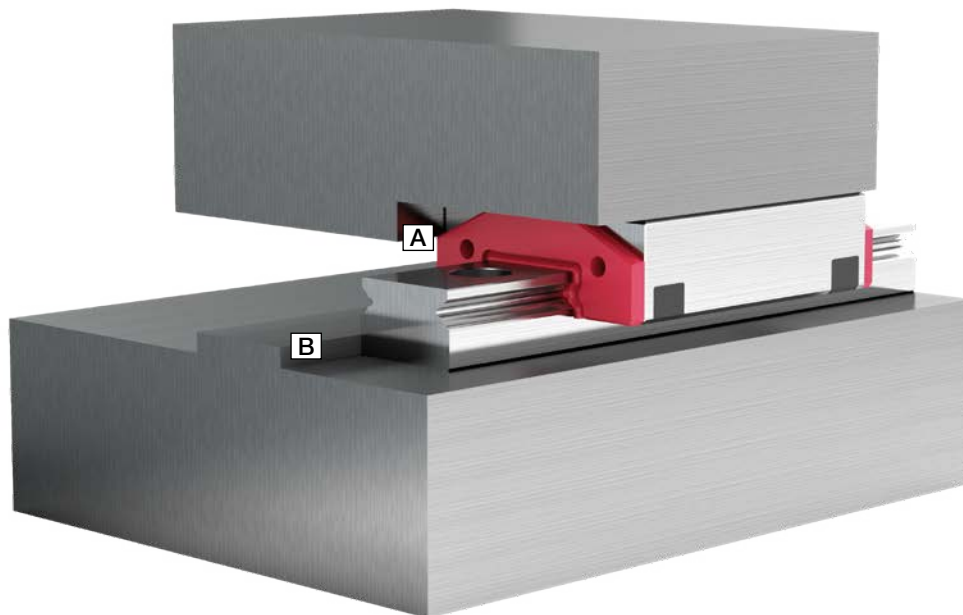

Reference surfaces

A Reference on the mounting plate for the carriage

B Reference on the machine bed for the guideway (both sides of the guideway can be used as reference surfaces)

16 Installation and Adjustment Guidelines for MINIRAIL and MINISCALE PLUS

16.3.3 Lubrication of MINIRAIL



Initial lubrication

Unless specified otherwise, carriage and guideway are delivered separately (see chapter 18.1). They are delivered unlubricated and must have a suitable lubricant for the application before operating.

A) Oil lubrication

For lubrication with oil, mineral oil CLP (DIN 51517) or HLP (DIN 51524) with a viscosity range between ISO VG32 and ISO VG150 in accordance with DIN 51519 is recommended.

Guideway:

The tracks of the guideway should be coated in a thin film of oil using a lint-free cloth soaked with oil (also applies when using the optional LUBE-S. See chapter 8.1).

Carriage:

The wipers on the carriages each feature two lubrication holes (see chapter 7.1.8), so that the left and right ball recirculation pathways can be lubricated separately. During lubrication, the carriages should be moved along the entire length of the rail so that the lubricant is applied to both the carriage and guideway. Ensure both tracks are properly lubricated.



Relubrication set (MNW), contents 7 ml

A relubrication set with KLÜBER Structovis GHD can be ordered from SCHNEEBERGER, part number MNW.

B) Grease lubrication

For lubrication with grease, lubricating grease KP2K or KP1K is recommended in accordance with DIN 51825.

Guideway:

The tracks of the guideway should be coated in a thin film of grease using a lint-free cloth (also applies when using the optional LUBE-S. See chapter 8.1).

Carriage:

The following quantities of grease should be applied to the ball bearings with an applicator.

| | | | | | | | | | |
|------------------------------------|---------|---------|----------|----------|---------|---------|---------|---------|--|
| Short carriages | MNNS 7 | MNNS 9 | MNNS 12 | MNNS 15 | | | | | |
| Grease quantity in cm ³ | 0.03 | 0.05 | 0.09 | 0.16 | | | | | |
| Standard carriages | MNN 7 | MNN 9 | MNN 12 | MNN 15 | MNN 14 | MNN 18 | MNN 24 | MNN 42 | |
| Grease quantity in cm ³ | 0.04 | 0.09 | 0.15 | 0.25 | 0.05 | 0.11 | 0.20 | 0.33 | |
| Long carriages | MNNL 7 | MNNL 9 | MNNL 12 | MNNL 15 | MNNL 14 | MNNL 18 | MNNL 24 | MNNL 42 | |
| Grease quantity in cm ³ | 0.05 | 0.11 | 0.20 | 0.35 | 0.07 | 0.14 | 0.26 | 0.45 | |
| Extra long carriages | MNNXL 7 | MNNXL 9 | MNNXL 12 | MNNXL 15 | | | | | |
| Grease quantity in cm ³ | 0.07 | 0.14 | 0.26 | 0.45 | | | | | |

After the ball bearings have been greased, the carriages should be moved along the entire length of the rail so that the lubricant is applied to both the carriage and guideway.

16 Installation and Adjustment Guidelines for MINIRAIL and MINISCALE PLUS

Relubrication intervals

The relubrication interval depends on many variables, e.g. load, working environment, speed, etc. and therefore cannot be calculated. The lubrication point must therefore be observed over a longer period of time.

A) Relubrication with oil



Relubrication set (MNW), contents 7 ml

A relubrication set with KLÜBER Structovis GHD can be ordered from SCHNEEBERGER, part number MNW.

The two lubrication holes in the front plates allow the ball recirculation pathways to be lubricated with oil directly (see chapter 7.1.8). Ensure both tracks are properly lubricated.

During lubrication, the carriages should be moved along the entire length of the rail so that the lubricant is applied to both the carriage and guideway.

B) Relubrication with grease

The tracks of the guideway should be coated in a thin film of grease using a lint-free cloth. The carriages should then be moved along the entire length of the rail so that the lubricant is applied to the ball bearings and distributed along the guideway.

16.3.4 Lubrication of MINISCALE PLUS

Please refer to the MINISCALE PLUS mounting instructions in the download section of www.schneeberger.com

16 Installation and Adjustment Guidelines for MINIRAIL and MINISCALE PLUS

16.4 Installation

16.4.1 General

- Before installation, the guideway, machine bed, mounting plate and fastening screws must all be at room temperature
- Always tighten the fastening screws with a torque wrench. See chapter 16.5 for torque values
- Always press the reference surface of the guideway against the reference surface of the machine bed. The guideway can be located on both sides, the reference side of the carriage is opposite the carriage side with the company logo / type designation

16.4.2 MINIRAIL and MINISCALE PLUS

- Alternate between sides of the guideway, starting at the middle, when tightening fastening screws. Pay attention to guideways on multi-part MINIRAIL systems (chapter 8.2)

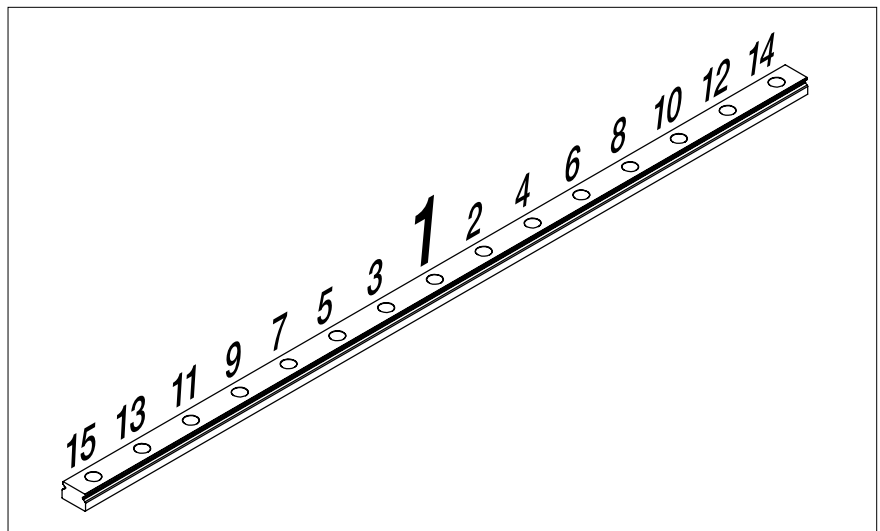

Fixing MINIRAIL guideways correctly

16.4.3 MINIRAIL



A protective plastic guideway is included on delivery (matched deliveries are the exception). The carriages should be transferred directly from the protective plastic guideway onto the steel guideway. This prevents dirt from getting into the carriages or the carriages from tilting which could lead to the loss of ball bearings.



Carriage on the protective plastic guideway before being transferred onto the steel guideway

16 Installation and Adjustment Guidelines for MINIRAIL and MINISCALE PLUS

16.5 Tightening Torques for the Fastening Screws

The recommended torque values can be found in the table. These values apply to oiled screws with a coefficient of friction of 0.12.

The coefficient of friction can be as low as 0.07 for lubricated screws. The corresponding torque values should be reduced by half.

The following table shows the torque values for the fastening screws of strength class 12.9 (friction coefficient 0.125) and of the strength class A2-70 (friction coefficient 0.2) in accordance with DIN 912:

| Thread size | Maximum tightening torque in Ncm | |
|-------------|----------------------------------|----------------------|
| | Strength class 12.9 | Strength class A2-70 |
| M1.6 | 28 | 20 |
| M2 | 60 | 30 |
| M3 | 210 | 110 |
| M4 | 500 | 260 |

16.6 Specific Information on MINISCALE PLUS

Information on installation and start-up of MINISCALE PLUS can be found in the download section of www.schneeberger.com.

17 Load Carrying Capacity and Service Life

17.1 Principles

The load capacities are based on the principles of DIN 636.

In accordance with DIN in most applications a permanent overall deformation of 0.0001 times the rolling element diameter can be permitted without adversely affecting the operating behaviour of the bearing. Consequently, the static load capacity C_0 is set sufficiently high that the aforementioned deformation occurs approximately when the equivalent static load corresponds to the static load capacity. Being guided by the dynamic load capacity C is recommended so that the aforementioned overall deformation does not occur.

The dynamic load capacity C is the load at which a nominal service life L of 100 km of travel distance is achieved. It is important to note when calculating the service life that not only the load, which acts vertically on the guideway, should be taken into account but also the load spectrum of all acting forces and moments.

The service life corresponds to the total travel distance in meters which a guideway facilitates. And this is before any noticeable material fatigue on one of the roller guideway elements. The nominal service life is achieved when 90% of the guideways of identical construction reach or exceed the corresponding travel distances under normal operating conditions.

Critical for the dimensioning of the guideways are the loads occurring proportionally with the dynamic load capacity C .

The dynamic load capacity C as given in the catalog corresponds to (\cong) the definition of C_{100} .

Definition of service life

As previously mentioned, the dynamic load capacity C_{100} is based on a service life of 100 km. Other manufacturers frequently indicate the load capacity C_{50} for a service life of 50 km. The resulting load capacities from this are more than 20% higher than specified by the DIN ISO standard.

Conversion example for ball bearings

Convert C_{50} load capacities to C_{100} in accordance with the DIN ISO standard:

$$C_{100} = 0.79 \cdot C_{50}$$

Convert C_{100} load capacities to C_{50} :

$$C_{50} = 1.26 \cdot C_{100}$$

C_{50} = dynamic load capacity C in N for 50 km of travel distance
 C_{100} = dynamic load capacity C in N for 100 km of travel distance, defined in accordance with DIN ISO standard

17 Load Carrying Capacity and Service Life

17.2 Calculation of Service Life L in Accordance with the DIN ISO Standard

17.2.1 The Formula for Calculating the Nominal Service Life for Ball Guideways in Meters is as follows:

$$L = a \cdot \left(\frac{C_{\text{eff}}}{P} \right)^3 \cdot 10^5 \text{ m}$$

a = Event probability factor
 C_{eff} = Effective load carrying capacity N
 P = Dynamic, equivalent load in N
 L = Nominal service life in m

Event probability factor a

The load carrying capacities for roller-contact bearings correspond to the DIN ISO standard. This represents a value from the service life calculation, which has a 90% chance of being exceeded during operational use of the guideway.

If the previously mentioned theoretical service life probability factor of 90% is not sufficient, the service life values will need to be adjusted by a factor a.

| Event probability in % | 90 | 95 | 96 | 97 | 98 | 99 |
|------------------------|----|------|------|------|------|------|
| Factor a | 1 | 0.62 | 0.53 | 0.44 | 0.33 | 0.21 |

17.2.2 The Formula for Calculating Nominal Service Life in Hours is as follows:

$$L_h = \frac{L}{2 \cdot s \cdot n \cdot 60} = \frac{L}{60 \cdot v_m}$$

L = Nominal service life in m
 L_h = Nominal service life in h
 s = Stroke length in m
 n = Stroke frequency in min⁻¹
 v_m = Medium travelling speed in m/min

17.2.3 Effective Load Carrying Capacity C_{eff}

Constructive and external influences can reduce the dynamic load capacity C of MINI-X products in such a way that C_{eff} must be calculated.

$$C_{\text{eff}} = f_K \cdot C$$

C_{eff} = Effective load carrying capacity N
 f_K = Contact factor
 C = Maximum permissible dynamic load carrying capacity in N

17 Load Carrying Capacity and Service Life

Contact factor f_k

If multiple carriages are mounted back-to-back with minimal spacing ($L_b < L$), an even weight distribution will be difficult to achieve due to the manufacturing tolerances of the guideway elements and mounting surfaces. Installation situations such as these can be allowed for with the contact factor f_k :

| | | | | | |
|----------------------|---|------|------|------|------|
| Number of carriages | 1 | 2 | 3 | 4 | 5 |
| Contact factor f_k | 1 | 0.81 | 0.72 | 0.66 | 0.62 |

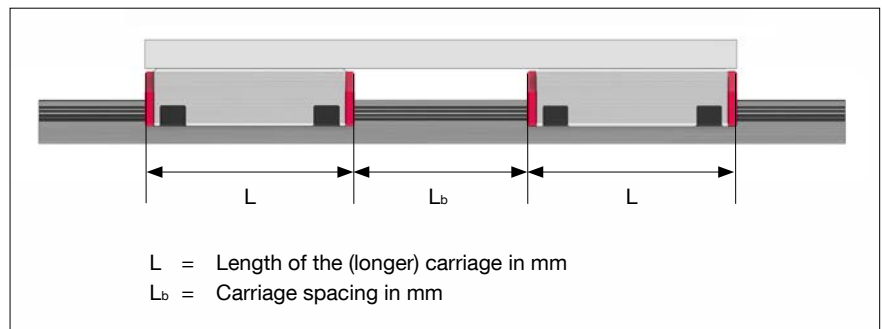

17.2.4 Dynamically Equivalent Load P

Stepped load

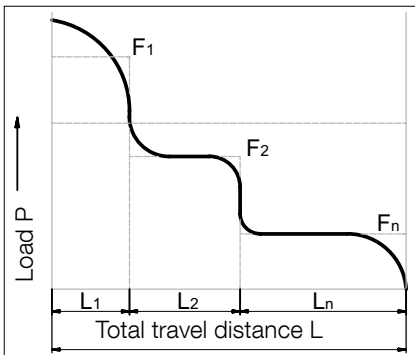

The loads (F) acting on a linear guideway system are subject to frequent fluctuations during operation. This set of circumstances should be taken into account when calculating service life. The varying load absorption of the guideway at varying operating conditions during the travel distance is described as being the dynamic equivalent load P .

$$P = \sqrt[3]{\frac{1}{L}(F_1^3 \cdot L_1 + F_2^3 \cdot L_2 + \dots + F_n^3 \cdot L_n)}$$

Sinusoidal load

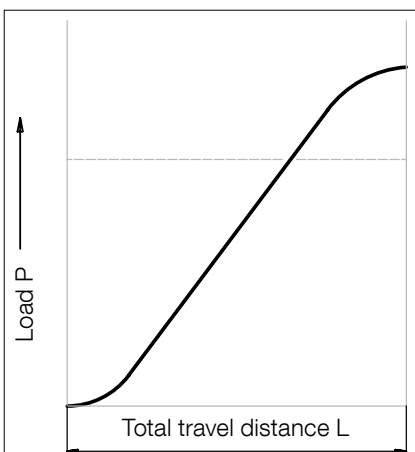

$$P = 0.7 F_{max}$$

- P = Equivalent load in N
- $F_1 \dots F_n$ = Individual load in N during the partial travel distance $L \dots L_n$
- F_{max} = Max. load in N
- L = $L_1 + \dots + L_n$ = Total travel during one load cycle in mm
- $L_1 \dots L_n$ = Partial travel distance in mm of one individual load during a load cycle

18 Handling, Storage and Transport

18.1 Delivered Condition (Standard Version)

All guideway components are delivered in adequate packaging. Accessories are included in separate packaging.



MINIRAIL guideways are delivered unlubricated as standard (lubrication in the factory on request) so that they can be lubricated in a way specific to the required application.

Guideways

The guideways are packed in VCI paper as standard.



Packaging of MINIRAIL guideways

Carriages

The carriages are delivered in varying sizes of packaging depending on the quantity ordered. They are mounted onto a plastic guide rail which provides protection during transport and aids in installation.



Packaging of MINIRAIL carriages

Delivered as a set

Carriages and guideways are delivered mounted (including for «height-matched carriages HA» or «push force defined VD» options).



MINIRAIL package as a set

MINISCALE PLUS

The complete axis (guideway with carriage) is delivered as a ready-built set. All components (MINISCALE PLUS and MINIRAIL) are lubricated with KLÜBER Isoflex NBU15.



MINISCALE PLUS packaged as a set



Important:

The order can be placed at www.schneeberger.com using the contact form under the "Request for quote" tab on the relevant product page. The sales representative for the product will then get back to you.

MINISLIDE

MINISLIDE products are lubricated with Klübersynth GE 46-1200 lubricant and are delivered ready to install.



MINISLIDE packaging

18 Handling, Storage and Transport

18.2 Handling and Storage

MINI-X products are high-precision components and should be handled with care. For transportation of these products in-house, the following points should therefore be noted:

- Transport guideways and accessories in their original packaging
- Protect guideways against impacts
- Always transport MINIRAIL and MINISCALE PLUS carriages on guide rails or on the protective plastic rail

The following instructions should be noted to protect against damage:

- Storage in the original packaging is only possible for a limited period. The condition of the products should be checked at regular intervals.
- Do not store the products in the open. Protect them against moisture and humidity (10% – 70% non-condensing)
- Pay attention to the temperature:

| | |
|----------------|--------------------|
| MINIRAIL | -40 °C to + 80 °C |
| MINISCALE PLUS | -40 °C to + 80 °C |
| MINISLIDE MS | -40 °C to + 80 °C |
| MINISLIDE MSQ | -40 °C to + 150 °C |
- Only remove the products from their original packaging at their installation location and immediately prior to assembly.
- For guideways that are delivered ready-lubricated, the lubricant should be checked (the service life of the lubricant is limited).
- Always store MINIRAIL and MINISCALE PLUS carriages on the guide rail or plastic rail so that the rolling elements are protected.

Improper handling of the guideways can lead to preliminary damage and thus to premature failure. Installation should therefore only be carried out by a qualified technician.

19 Ordering Information

19.1 MINIRAIL

Carriages and guideways should be ordered separately

| Carriages | 100 | MNN | | 9- | | | | G1- | | | LS- | VD- | HA- | KB- | US- | VA- | AS, AL, OA |
|--|---|-----|----|----|------|------|------|-----|-----|----|-----|-----|-----|-----|-----|-----|------------|
| Guideways | 50 | | MN | 9- | 155- | 7.5- | 7.5- | G1- | V1- | ZG | | | | | | | |
| Quantity | | | | | | | | | | | | | | | | | |
| Carriage type | MNNS ^(B) , MNN, MNNL, MNNXL ^(B) | | | | | | | | | | | | | | | | |
| Rail type | MN | | | | | | | | | | | | | | | | |
| Size | 7, 9, 12, 15, 14, 18, 24, 42 | | | | | | | | | | | | | | | | |
| Rail length L ₃ | in mm | | | | | | | | | | | | | | | | |
| Start hole spacing L ₅ ^(C) | in mm | | | | | | | | | | | | | | | | |
| End hole spacing L ₁₀ ^(C) | in mm | | | | | | | | | | | | | | | | |
| Accuracy class | G1 or G3 | | | | | | | | | | | | | | | | |
| Preload class | V0 or V1 | | | | | | | | | | | | | | | | |
| Multi-part guideways | ZG | | | | | | | | | | | | | | | | |
| LUBE-S long-term lubrication | LS | | | | | | | | | | | | | | | | |
| Defined push force ^(A) | VD | | | | | | | | | | | | | | | | |
| Height-matched carriages ^(A) | HA | | | | | | | | | | | | | | | | |
| Customer-specific lubrication | KB | | | | | | | | | | | | | | | | |
| Cleaned with ultrasound | US | | | | | | | | | | | | | | | | |
| Vacuum packed | VA | | | | | | | | | | | | | | | | |
| Wipers ^(D) | AS, AL or OA | | | | | | | | | | | | | | | | |

^(A) This option is delivered as a set (carriage mounted on guideway)

^(B) Not available in sizes 14, 18, 24 and 42

^(C) Only to be quoted for non-standard orders

^(D) Standard wipers will be delivered unless this is stated. Type AL is only available for sizes 7, 9, 12 and 15

19.2 MINISCALE PLUS

The complete axis is delivered lubricated and ready to install. The order can be placed at www.schneeberger.com using the contact form under the "Request for quote" tab on the relevant product page. The sales representative for the product will then get back to you. Or define the parameters of individual components with one of the SCHNEEBERGER specialists.

19.3 MINISLIDE MS or MSQ

| Ordering sequence | 88 | MS | 5- | 40. | 31- | VD- | HA- | KB- | US- | VA |
|-------------------------------|--------------------|----|----|-----|-----|-----|-----|-----|-----|----|
| Quantity | | | | | | | | | | |
| Series | MS or MSQ | | | | | | | | | |
| Rail width B ₁ | 4, 5, 7, 9, 12, 15 | | | | | | | | | |
| System length L | in mm | | | | | | | | | |
| Stroke H | in mm | | | | | | | | | |
| Defined push force | VD | | | | | | | | | |
| Height-matched | HA | | | | | | | | | |
| Customer-specific lubrication | KB | | | | | | | | | |
| Cleaned with ultrasound | US | | | | | | | | | |
| Vacuum packed | VA | | | | | | | | | |